

A Fake Cusp and a Fishtail

Selman Akbulut

Dedicated to Robion Kirby on the occasion of his 60th birthday

Even though many fake smoothings of 4-manifolds are known to exist, we know little about the basic building blocks of exotic smooth manifolds. This is mainly due to the fact that we still don't know if basic manifolds like S^4 , $S^2 \times S^2$, and $S^1 \times S^3$ could admit fake smooth structures. Unable to show this, we demonstrate fake smooth structures on manifolds that are in a way “small deformations” of $S^2 \times B^2$ (as in [A1],[A2]).

Fishtail F is the tubular neighborhood of an immersed 2-sphere in S^4 with one self intersection; as a handlebody it can be described as a 4-ball with 1 and 2-handles attached as in first picture of Figure 1. Recalling the 1-handle notation of [A0], F is obtained by removing a tubular neighborhood of the obvious disc $B^2 \subset S^2 \times B^2$ (which the “circle with dot” bounds). Cusp C is a 4-ball with a 2-handle attached along a trefoil knot with 0-framing as shown in the second picture of Figure 1.

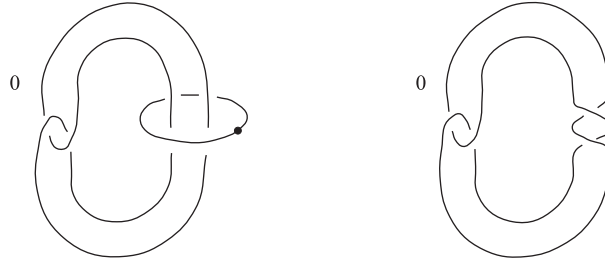

Figure 1

Theorem 0.1. *There are compact smooth manifolds F^* and C^* , which are homeomorphic but not diffeomorphic to F and C , respectively. Also, F^* is obtained by removing a tubular neighborhood of a properly imbedded 2-disc $f : B^2 \hookrightarrow S^2 \times B^2$ from $S^2 \times B^2$.*

In Figure 1 the circle $f(\partial B^2)$ corresponds to the circle with dot. Existence of a fake cusp was first established jointly with R. Matveyev as application of methods of [AM].

Partially supported by NSF grant DMS-9626204 and TÜBİTAK Feza Gürsey Institute.

1. Seiberg-Witten invariants

Let X be a closed smooth 4-manifold and $Spin_c(X)$ be the set of $Spin_c$ structures on X . In case $H_1(X)$ has no 2-torsion $Spin_c(X)$ can be identified by

$$Spin_c(X) = \{a \in H^2(X, \mathbf{Z}) \mid a = w_2(TX) \pmod{2}\}$$

Recall Seiberg-Witten invariant

$$SW_X : Spin_c(X) \rightarrow \mathbf{Z}.$$

A class $a \in H^2(X, \mathbf{Z})$ is called *basic* if $SW_X(a) \neq 0$. It is known that there are finitely many basic classes and if a is basic then so is $-a$, and

$$SW_X(-a) = (-1)^\varepsilon SW_X(a)$$

where $\varepsilon = (e(X) + \sigma(X)) / 4$, and $e(X), \sigma(X)$ denote Euler characteristic and signature. If $B = \{\pm\alpha_1, \pm\alpha_2, \dots, \pm\alpha_n\}$ are the basic classes, by denoting $a_0 = SW_X(0), a_j = SW_X(\alpha_j)$ and $t_j = \exp(\alpha_j)$ Seiberg-Witten invariants can be assembled a single polynomial [FS]

$$SW_X = a_0 + \sum_{j=0}^n a_i(t_j + (-1)^\varepsilon t_j^{-1}).$$

In [FS] Fintushel and Stern introduced a method of modifying a 4-manifold by using a knot in S^3 , which changes its Seiberg-Witten invariants without changing its homeomorphism type. Let X be a closed smooth 4-manifold and $T^2 \subset X$ be an imbedded 2-torus with trivial normal bundle. Assume that this torus lies in in a cusp neighborhood; this means that inside of X the tubular neighborhood $T^2 \times B^2$ of the 2-torus (first picture of Figure 2) is contained in a cusp C (the second picture Figure 2). Call such a 2-torus in X a *c-imbedded torus*.

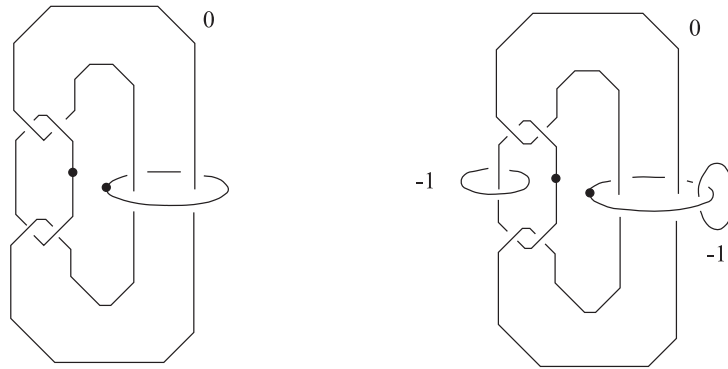

Figure 2

Let $K \subset S^3$ be a knot, and $N = N(K) \approx K \times B^2$ be the trivialization of its open tubular neighborhood given by the 0-framing. Let $\varphi : \partial(T^2 \times B^2) \rightarrow \partial(K \times B^2) \times S^1$ be any diffeomorphism with $\varphi(p \times \partial B^2) = K \times p$ where $p \in T^2$ is a point. Define:

$$X_K = (X - T^2 \times B^2) \smile_{\varphi} (S^3 - N) \times S^1.$$

Let $[T]$ be the homology class in $H_2(X_K; \mathbf{Z})$ induced from $T^2 \subset X$, and $t = \exp(2[T])$, and let $\Delta_K(t)$ be the Alexander polynomial of the knot K (as a symmetric Laurent polynomial), then

Theorem 1.1. [FS]: *Let X be a smooth manifold as above, and $K \subset S^3$ be a knot, then Seiberg-Witten invariants of X_K can be computed as*

$$SW_{X_K} = SW_X \cdot \Delta_K(t).$$

2. Handlebody of X_K

Here we will give a general algorithm of describing the handlebody description of X_K from the handles of X . It could be beneficial for the reader to compare the steps of this section with [A3]. Let $K \subset S^3$ be a knot, depicted as the left handed trefoil knot in Figure 3, and N be its open tubular neighborhood. We claim that the linking circles α and β are the *core circles* of the 1- handles of the handlebody of $S^3 - N$ (Heegaard diagram).

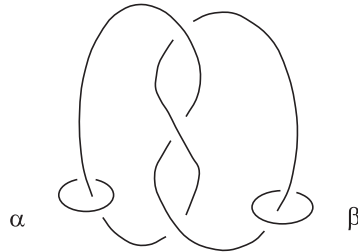

Figure 3

This can easily be checked by the process described in [R] pp.250, which turns a surgery description of a 3-manifold to its Heegaard diagram. Steps in Figure 4 describe this process (i.e. attach canceling pair of 1 and 2 - handles to $S^3 - N$ until the complement becomes a solid handlebody). Write:

$$(S^3 - N) \times S^1 = (S^3 - N) \times I_+ \smile (S^3 - N) \times I_-$$

where $I_{\pm} \approx I = [0, 1]$ are closed intervals and the union is taken along the boundaries, i.e. along $(S^3 - N) \sqcup (S^3 - N)$. Up to attaching a 3-handle, $(S^3 - N) \times I_-$ is obtained by removing the tubular neighborhood of a properly imbedded arc (with trefoil knot tied on it) from B^3 , and crossing it with I as indicated in Figure 5.

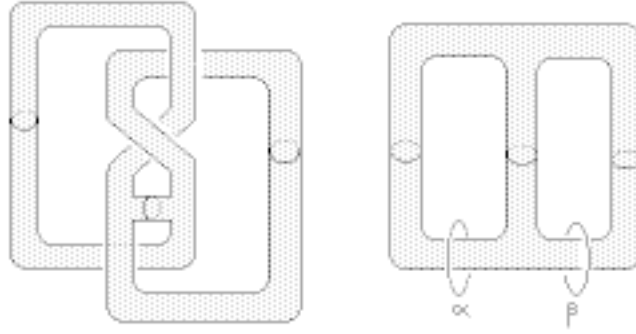

Figure 4

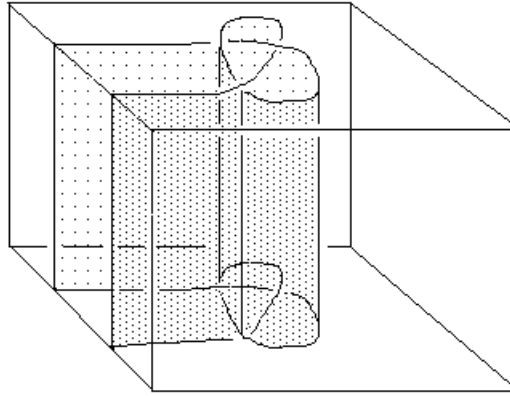

Figure 5

Equivalently, $(S^3 - N) \times I_-$ is obtained by removing the “usual” slice disc from B^4 , which trefoil knot connected summed with its mirror image $K \# (-K)$ bounds, as indicated in Figure 6. The dot on the knot $K \# (-K)$ in Figure 6 indicates that the tubular neighborhood of the obvious slice disc which it bounds is removed from B^4 . We will refer this as *slice 1-handle*. This notation was discussed in [AK] and [A3].

To get $(S^3 - N) \times S^1$ we glue the upside down handlebody of $(S^3 - N) \times I_+$ to $(S^3 - N) \times I_-$. Clearly, up to attaching 3-handles, this is achieved by attaching $(S^3 - N) \times I_-$ one 1-handle and two 2-handles, resulting from identification of the corresponding 1-handles α and β (of the knot complements) in the two boundary components of $(S^3 - N) \times I_-$, as indicated in Figure 7. So Figure 7 gives $(S^3 - N) \times S^1$.

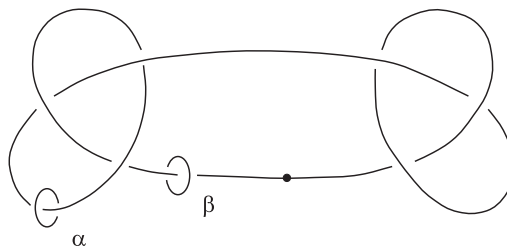

Figure 6

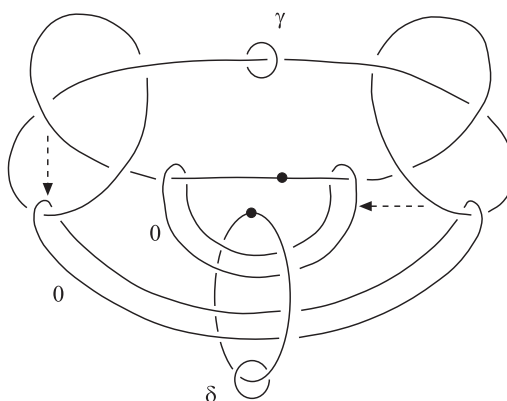

Figure 7

At this stage it is instructive to check that the boundary of the handlebody of Figure 7 is indeed T^3 . This can be seen by removing the “dot” from the “slice 1-handle” then performing handle moves as indicated by the arrows in Figure 7. This gives the first picture of Figure 8, then by sliding one of the 0-framed handles from the other one we get the second picture Figure 8. Since the trivial knot with 0-framing is canceled by a 3-handle, we see that Figure 8 is $T^2 \times B^2$ (with boundary T^3). Hence the reverse operation Figure 8 \rightarrow Figure 7 corresponds to the modification $X \rightarrow X_K$.

We can see the operation Figure 8 \rightarrow Figure 7 directly as follows: Start with $T^2 \times B^2$, by attaching a canceling pair of 2 and 3 handles (i.e. by introducing an unknot with 0-framing), and then by sliding this new 2-handle over the 2-handle of $T^2 \times B^2$ we get another handle description of $T^2 \times B^2$ in Figure 9. Now by removing the “dot” on the 1-handle (i.e. by surgery turning 1-handle $S^1 \times B^3$ to $B^2 \times S^2$) and performing the handle slides as indicated by the arrows of Figure 9 (and putting a “dot” on a resulting 0-framed knot), we get Figure 7. The “circled 1/2 notation” on one of the arrows of Figure 9 means that when doing handle slide put one half-twist on the band.

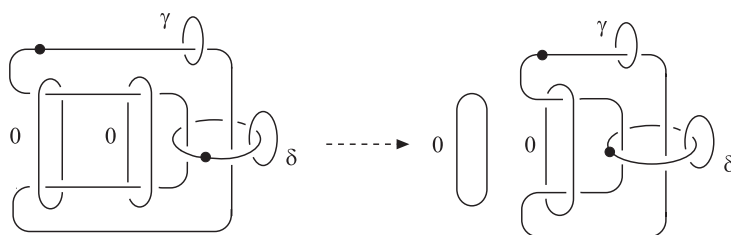

Figure 8

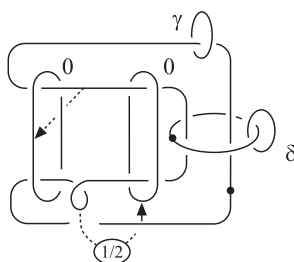

Figure 9

Hence to see exactly how the operation $X \rightarrow X_K$ modifies the handles of X we simply apply this process to an imbedded $T^2 \times B^2$ inside X , and trace the rest of the other handles of X along with it. For example, the operation Figure 9 \rightarrow Figure 7 preserves the linking circles γ and δ , as indicated in the figures. Therefore, if $T^2 \times B^2$ lies in a cusp neighborhood in C (i.e. if there are -1 framed handles attached to the knots γ and δ of Figure 9), Figure 9 becomes Figure 10, and the operation $X \rightarrow X_K$ corresponds to the operation Figure 10 \rightarrow Figure 11 (here disregard the loop τ in Figures 10 and 11, it will be explained in the next paragraph).

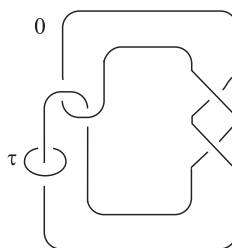

Figure 10

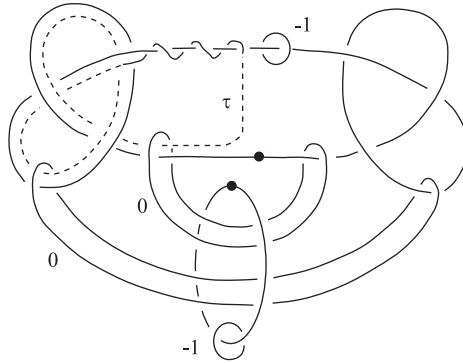

Figure 11

Warning: even though the operation Figure 9 \rightarrow Figure 7 preserves the loops γ, δ of the 1-handles, it does not preserve the linking circle τ of the 2-handle of $T^2 \times B^2$. Hence for example, τ of the cusp of Figure 10 is sent to the quite complicated loop of Figure 11 (also denoted by τ). Finally by drawing the slice 1-handle of Figure 11 as two 1-handles and one 2-handle, we see that Figure 11 is diffeomorphic to Figure 12 (canceling one of the 1-handles of Figure 12 by the “middle” 2-handle gives the slice 1-handle of Figure 11, as in [A3]).

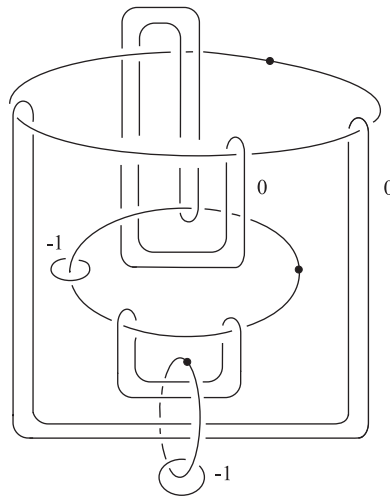

Figure 12

To sum up: The operation $X \rightarrow X_K$ changes an imbedded $T^2 \times B^2$ inside of X by changing one of its 1-handles with a “slice 1-handle” determined by the knot $K \# (-K)$, and introducing 2-handles connecting the “core circles” of 1-handles of the two knot complements (all except one) as in Figure 13.

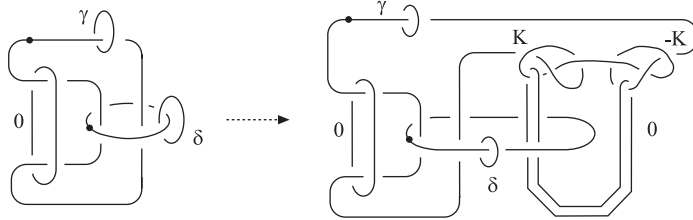

Figure 13

3. Proof of the theorem

Attaching 2-handles with -1 framings to γ and δ of the first picture of Figure 13 gives the cusp C . By Eliashberg’s theorem C is compact Stein manifold (see [AM] for brief review). C can be compactified to a Kähler manifold X ; for example C sits in a K3 surface as a codimension zero submanifold. By applying Theorem 1.1 to the torus $T^2 \subset C \subset X$, and a knot K is with nontrivial Alexander polynomial, we obtain a fake copy X_K of X (because X_K has different Seiberg-Witten invariant than X). Define $C^* = C_K \subset X_K$, then C^* can not be diffeomorphic to C , otherwise the identity map $id : X - \text{int}(C) \rightarrow X_K - \text{int}(C^*)$ would extend to a diffeomorphism $X \rightarrow X_K$. Recall that all self-diffeomorphisms of the boundary of the cusp C extends to C . Figure 12 is the handlebody of C^* (in case K is the trefoil knot)

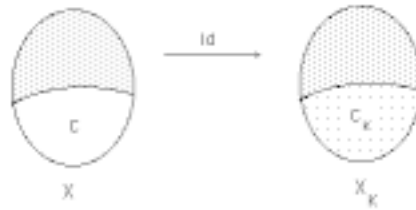

Figure 14

Attaching one 2-handle with -1 framings to either one of the circles γ or δ (say to γ) of the first picture of Figure 13 gives the fishtail F . We can think of F being obtained

from C by “undoing” one of its 2-handles, i.e. removing a thickened disc D from C (dual 2-handle of δ). The boundary ∂D corresponds the small trivially linking circle of the -1 framed circle δ ; so removing D from C corresponds to putting a “dot” on this dual circle (and hence canceling the 2-handle δ from C). By extending $id : X - \text{int}(C) \rightarrow X_K - \text{int}(C^*)$ across D gives a diffeomorphism $f : \partial F \rightarrow \partial F_K$ which does not extend over the interior (otherwise X and X_K would be diffeomorphic).

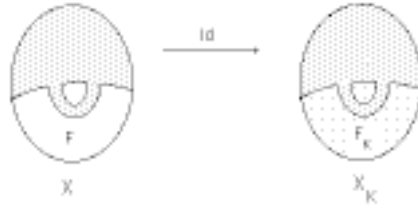

Figure 15

Define $F^* = F_K$, so removing thickened D from C^* (Figure 11) gives F^* (Figure 16). It is easy to verify that F^* is homotopy equivalent to F . Furthermore we can verify that F^* is obtained from $S^2 \times B^2$ by removing an imbedded disc D as follows: By the handle moves of Figure 7, we see that on the boundary the position of the unknotted “circle with dot” of Figure 16 is the same as the “circle with dot” of Figure 1 (i.e. F); also removing the ‘circle with dot’ from Figure 16 results $S^2 \times B^2$ (this can be verified by going from Figure 16 to the handle presentation of Figure 12).

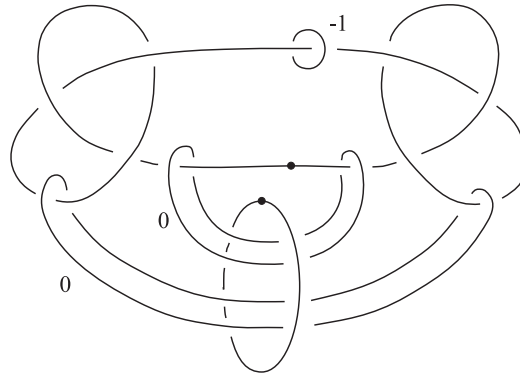

Figure 16

It remains to be checked that F^* is not diffeomorphic to F ; so far we only know a particular diffeomorphism of $f : \partial F \rightarrow \partial F^*$ does not extend inside. Unfortunately unlike C , not every self diffeomorphism of ∂F extends over F . But from the construction it is easy to see that f extends to a homotopy equivalence $F^* \rightarrow F$, hence the following lemma implies that F^* can not be diffeomorphic to F .

Lemma 3.1. *If a diffeomorphism $f : \partial F \rightarrow \partial F$ extends to a self homotopy equivalence it extends to a diffeomorphism $F \rightarrow F$.*

Proof. (outlined by R.Gompf): It is known that ∂F is a T^2 bundle over S^1 with monodromy $\begin{pmatrix} 1 & 1 \\ 0 & 1 \end{pmatrix}$ [K]. By standard 3-manifold theory f can be isotoped to a fiber preserving isotopy. By composing with obvious diffeomorphism that extends, we can assume that the fiber orientation is preserved. Since f has to commute with monodromy it fixes the “vanishing cycle” C , corresponding to $(1, 0)$. So f is a composition of Dehn twist along the horizontal torus $C \times S^1$ along S^1 direction, and Dehn twist along the fiber in C direction (Dehn twist orthogonal to C is ruled out since it does not extend to homotopy equivalence $F \rightarrow F$), all these diffeomorphisms extend to F . \square

4. Exotic knottings of the cusp and the fishtail

We can describe S^4 as a union of two fishtails along the boundary, and $S^2 \times S^2$ as a union of two cusps along the boundary. Figure 17 describe these identifications. For example, attaching an upside-down copy of $-F$ to F has an affect of attaching a 2 and 3-handles to F as described in the first part of Figure 17: Attaching the 2-handle to F gives $S^2 \times B^2$ which, after attaching a 3-handle, becomes S^4 . Hence we have imbeddings of singular 2-spheres $f_0 : F \rightarrow S^4$ and $g_0 : C \rightarrow S^2 \times S^2$

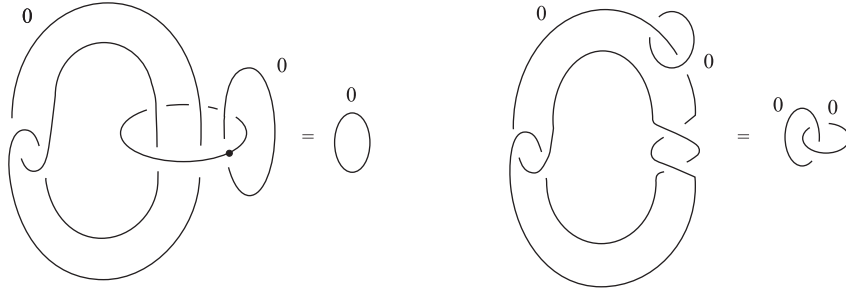

Figure 17

Theorem 4.1. *There are imbeddings $f_1 : F \rightarrow S^4$ and $g_1 : C \rightarrow S^2 \times S^2$ that are topologically isotopic but not smoothly isotopic to the imbeddings f_0 and g_0 .*

Proof. By replacing one of the fishtails in $S^4 = F \cup_{\partial} -F$ by F^* we obtain a homotopy 4-sphere, which can be easily checked to be $S^4 = F^* \cup_{\partial} -F$ (Figure 18). Similarly by replacing one of the cusps in $S^2 \times S^2 = C \cup_{\partial} -C$ we obtain a homotopy $S^2 \times S^2$ which can be checked to be the standard $S^2 \times S^2 = C^* \cup_{\partial} -C$. Unlike the previous case, this check is surprisingly difficult (it requires the proof of Scharlemann's conjecture).

Figure 19 is the handlebody of $C^* \cup_{\partial} -C$, it is diffeomorphic to Figure 20 (to see this, in Figure 20 slide one of the small -1 circles over one of the 0 -framed handles, going through the 1 -handle, then slide -1 framed 2 -handle over it). To identify Figure 20 by $S^2 \times S^2$ we need to first recall the handlebody picture of $\Sigma \times S^1$, where Σ is the Poincaré homology sphere ([A3]): Figure 21. From [A3] we know that surgering $\Sigma \times S^1$ (along the loop trivially linking the slice 1 -handle) gives $S^3 \times S^1 \# S^2 \times S^2$, and surgering once more the obvious S^1 gives $S^2 \times S^2$. Performing these two surgeries corresponds to introducing pair of 0 and -1 framed two handles as indicated in Figure 22. By canceling two 2 and 3 -handle pairs from Figure 22 gives Figure 20. Via the handle moves of Figure 7 one can check that, introducing the two little 0 -framed handles to Figure 20, to obtain Figure 22, has the effect of changing the boundary from $S^1 \times S^2$ to $S^1 \times S^2 \# S^1 \times S^2 \# S^1 \times S^2$. \square

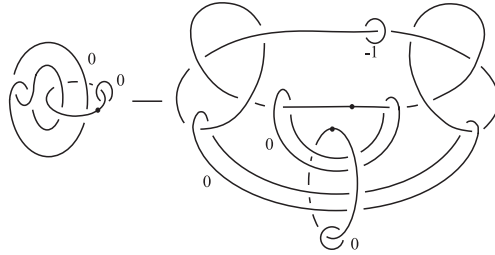

Figure 18

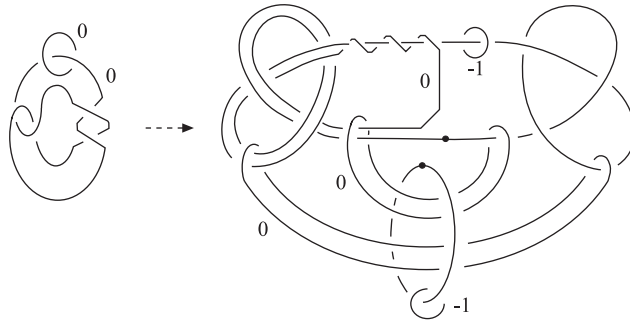

Figure 19

Remark 4.1. The Fintushel-Stern operation $X \rightarrow X_K$ can be generalized by

$$X \rightarrow X_T = (X - T^2 \times B^2) \smile_{\varphi} (S^3 \times S^1 - N_T)$$

where N_T is an open tubular neighborhood of an imbedded $T^2 \subset S^3 \times S^1$. Surprisingly it turns out that this operation does not always change the smooth structure of X (in particular it does not change the Seiberg-Witten invariant of X). Another generalization of this operation is by removing an open tubular neighborhood of a Klein bottle $N(F)$ (a twisted B^2 -bundle over F) from X , and replacing it with a $S^3 - N(K)$ bundle over S^1 , where $K \subset S^3$ is an invertible knot and $\psi : S^3 - N(K) \rightarrow S^3 - N(K)$ is the inversion

$$X \rightarrow X_K = (X - N(F)) \smile_{\partial} (S^3 - N(K)) \times_{\psi} S^1.$$

These operations will be studied in [A4].

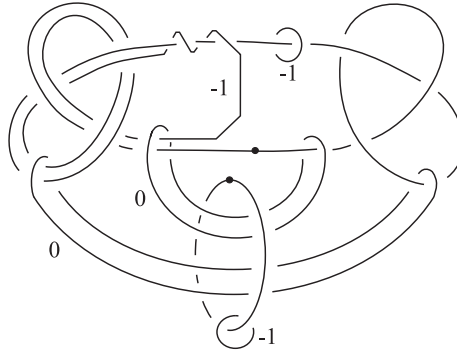

Figure 20

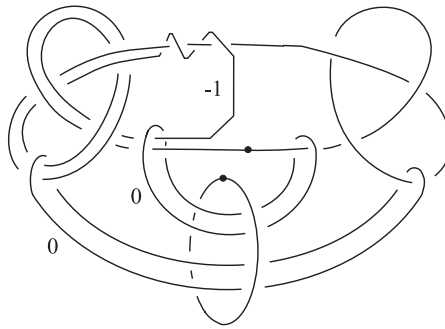

Figure 21

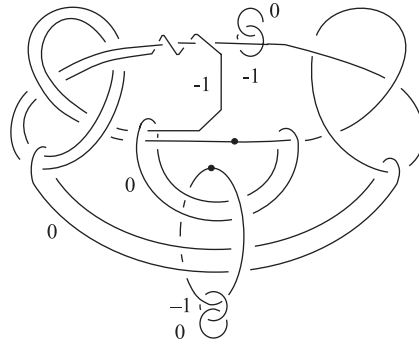

Figure 22

References

- [A0] S. Akbulut, *On 2-dimensional homology classes of 4-manifolds*, Math. Proc. Camb. Phil. Soc. **82** (1977), 99-106.
- [A1] S. Akbulut, *A Fake compact contractible 4-manifold*, Journ. of Diff. Geom. **33**, (1991), 335-356.
- [A2] S. Akbulut, *An exotic 4-manifold*, Journ. of Diff. Geom. **33**, (1991), 357-361.
- [A3] S. Akbulut, *Scharlemann's manifold is standard*, (to appear in Ann of Math).
- [A4] S. Akbulut, *Modifications of 4-manifolds* (in prep.).
- [AK] S. Akbulut and R. Kirby, *Branched covers of surfaces in 4-manifolds*, Math. Ann. **252** (1980), 111-131.
- [AM] S. Akbulut and R. Matveyev, *Exotic structures and adjunction inequality*, Proceedings of 5th Gökova Geometry-Topology Conference (distributed by IP press) (1997).
- [FS] R. Fintushel and R. Stern, *Knots, links, and 4-manifolds*, Invent. Math. **134** (1998), no. 2, 363-400.
- [K] K. Kodaira, *On compact analytic surfaces III*, Ann. Math. **78**, (1963) 563-626.
- [GS] R. Gompf and A. Stipsicz, *An introduction to 4-manifolds and Kirby calculus*, book in preparation.
- [R] D. Rolfsen, *Knots and links*, Math. lecture series no.7, Publish or Perish, inc. (1976).

MICHIGAN STATE UNIVERSITY, DEPT OF MATH, E.LANSING, MI, 48824, USA
E-mail address: akbulut@math.msu.edu